

**GAM** Overview and Product Range

YOUR COMPLETE SOURCE FOR  
**PRECISION  
MECHANICAL  
DRIVE SOLUTIONS**

*Gear Reducers*

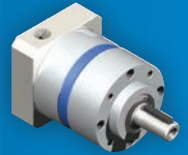

*Couplings*

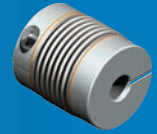

*Mounting Kits*

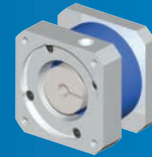

*Rack & Pinion*

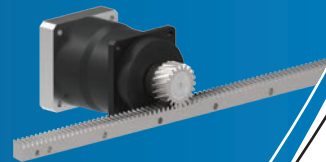

**GAM**

GAM CAN.

# GAM - Corporate Overview



## About GAM

Founded in 1990 by Gary A. Michalek, GAM is a U.S. owned and operated manufacturer of precision motion control components used in automation technology. We offer a broad product range of robotic and servo gear reducers, rack and pinion systems, servo couplings, linear mounting kits, and other specialized mechanical drive solutions. Our customers are in a wide variety of industries including aerospace, automotive, medical, material handling, energy, packaging, machine tool, robotics and semiconductor.

## What makes us different?

1. Broad range of standard products
2. Collaboration and flexibility to provide customized solutions at a value to our customers
3. Excellent customer service — we are great to work with

## Our mission is to be flexible and give great service!

We are the market leader, known for our flexibility to offer our customers the best solution to meet their unique application requirements. We are passionate about helping our customers and employees be successful! Our customer service is driven through the entire organization and our lean manufacturing enables us to deliver standard, modified, or customized products quickly, and at a price that is a value, no matter what quantity.

## Capabilities

- Application Engineering: *Upfront collaboration to understand customer requirements*
- Design Engineering: *Highly skilled team of engineers to develop standard, modified, and customized solutions*
- U.S. Manufacturing: *Flexible systems, state-of-the-art CNC equipment and assembly cells to bring the ideas to life*
- Quality Control: *Quality management system and dedicated staff to ensure products are produced to specification*

## Our Core Values

- Teamwork
- Action-Oriented
- Long-term Relationships
- Professionalism
- Fun

# The GAM Advantage

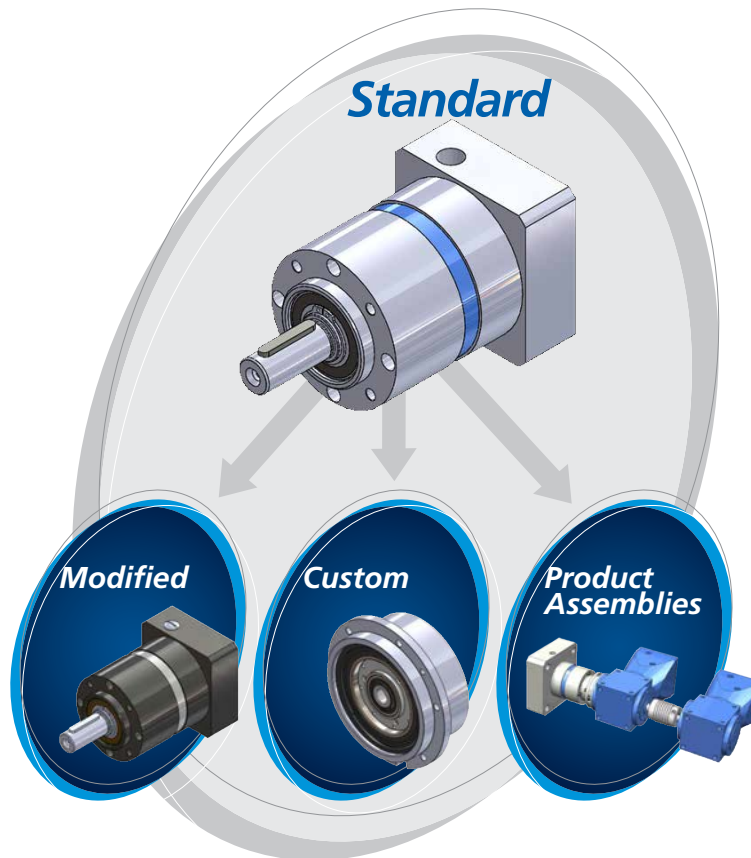

## Find the exact solution you are looking for at GAM!

GAM's product range of gear reducers, rack and pinion, couplings, and other specialized mechanical drive solutions is one of the largest in the industry. Even with such a wide offering, we realize that you may not find a standard product that meets your exact requirements.

One of our greatest strengths is our ability to modify standard designs, provide completely customized solutions, and integrated product assemblies to meet your specific application requirements. Collaborate with GAM engineers to design the best solution to your application. And, because of our flexible manufacturing, we can cost-effectively produce small batches of customized product in short lead-times.

### So if you can't find what you are looking for, just ask!

A few examples of our customized solutions:



Standard GPL zero-backlash planetary gearbox in custom housing with integrated shrink disk connection. Works with any servo motor and output mounting. Drops in for competitive direct drive motors.



Inline planetary gearbox with spline output shaft. External tie rods reinforce against reversing or shock loads.



Robot 7th axis: Dyna Series right angle hypoid gearbox with additional external bearing support and adjustable pinion shaft length. Eliminates in-house assembly. Just mount and go!



Flange output gearbox with special input shaft designed for explosion-proof application

## Highest Precision (<1 arcmin) - Gear Reducers - Robotics

Inline Right Angle

### GPL Planetary

The GPL is the best performing zero-backlash robotic inline gearbox on the market

- Lowest backlash <0.1 arcmin, 10 times better than other zero-backlash gearboxes
- Vibration free with high positional accuracy for smooth tracking
- Revolutionary design maintains zero backlash over the life of the gearbox, no adjustment needed
- Torsional rigidity up to 1,359 Nm/arcmin with Torque capacity up to 3,000 Nm
- Radial load capacity up to 61,900 N
- Frame sizes from 180 to 330 mm
- Integrated pre-stage and motor mount

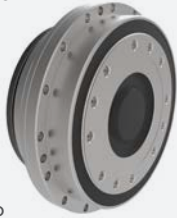

### GCL Cycloidal

Robotic inline cycloidal gearbox with high impact resistance

- Lowest backlash <1 arcmin
- Impact resistance 5x nominal torque withstands frequent start-stop impact loads
- Torque capacity up to 4,900 Nm
- Frame sizes from 145 to 520 mm
- Integral pre-stage options available
- Drops in for most popular competitor gearboxes

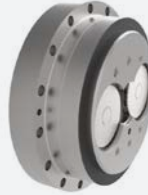

### GSL Strain Wave

Robotic strain wave (harmonic) inline gearbox with zero backlash and high torque density

- Lowest backlash <0.5 arcmin
- High repeatability and positional accuracy for fine positioning
- High reduction ratios in a single stage: 50:1 to 160:1
- High torque density with low inertia
- Torque capacity up to 160 Nm
- Compact, small gearbox with frame sizes from 11 to 40
- Multiple input configurations
- Integrated pre-stage and motor mount
- Drops in for popular competitor gearboxes



## High Precision - Rack & Pinion Systems

### Helical Rack & Pinion Systems

- High precision helical rack for smooth, quiet operation
- Precision pinions designed specifically for GAM gearboxes for optimized linear system performance
- GAM rack available separately or as part of a gearbox/pinion system

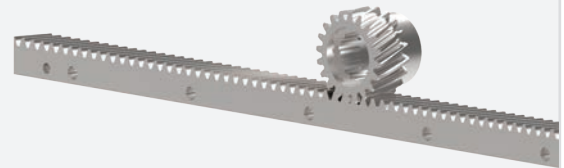

**PHGH-S**  
Spline Pinion



**PHGH-K**  
Keyed Pinion



**PHGH-W**  
Welded Flange Pinion



**PHGH-B**  
Bolt-Through Pinion

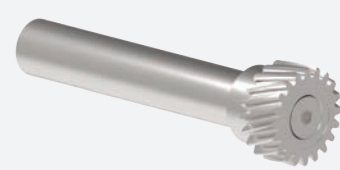

**PHGH-K**  
Shaft Pinion

### Inline Systems

Integrated gearbox-pinion systems



**SPH-SP**  
with PHGH-S Pinion



**SPH-FP**  
with PHGH-W Pinion



**EPL-AP**  
with PHGH-K Pinion



**EPL-FP**  
with PHGH-B Pinion

### Right Angle Systems

Integrated gearbox-pinion systems



**DS-FP**  
with PHGH-W Pinion



**DS-HP**  
with PHGH-D Pinion

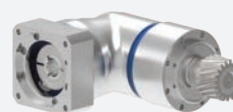

**EPR-AP**  
with PHGH-K Pinion



**EPR-FP**  
with PHGH-B Pinion

## High Precision (1-7 arcmin) - Gear Reducers - Motion Control

Inline Right Angle

### SPH Series

High performance inline planetary helical gearbox for demanding applications

- Lowest backlash <1 arcmin
- Torque capacity up to 900 Nm
- Torsional rigidity up to 168 Nm/arcmin
- Radial load capacity up to 20,000 N
- Frame sizes from 50-180 mm

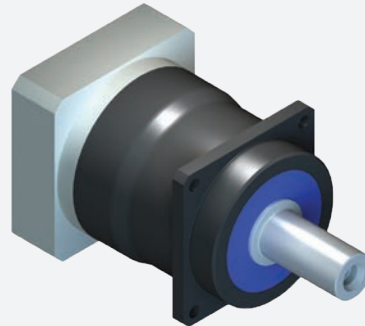

**SPH-W**  
Metric shaft output



**SPH-K**  
Integrated coupling output and lantern housing



**SPH-C**  
Integrated coupling output



**SPH-F**  
Compact flange output design

### Dyna Series

High performance right angle hypoid gearbox for demanding applications

- Lowest backlash <2 arcmin
- Torque capacity up to 1,400 Nm
- Torsional rigidity up to 126 Nm/arcmin
- Radial load capacity up to 20,000 N
- Frame sizes from 55-190 mm

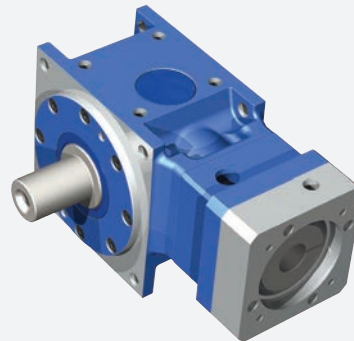

**DS-W**  
Metric shaft output



**DS-F**  
Flange output configuration



**DS-H**  
Hollow bore output configuration



**DS-T**  
Dual output shaft configuration

### Dyna-Lite Series

Performance right angle hypoid gearbox for general applications

- Lowest backlash <6 arcmin
- Torque capacity up to 140 Nm
- Torsional rigidity up to 10 Nm/arcmin
- Radial load capacity up to 7,200 N
- Frame sizes from 55-90 mm

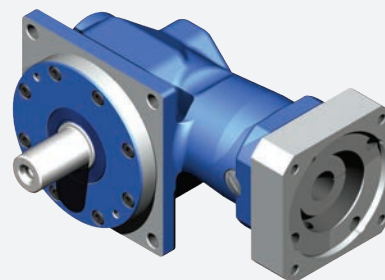

**DL-DW**  
Metric shaft output



**DL-DC**  
Hollow clamp output for direct mount to linear actuators



**DL-DH**  
Hollow bore output with Dyna Series dimensions



**DL-PW**  
Solid shaft output with dimensions that drop-in for many right angle and inline gear reducers

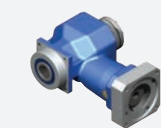

**DL-PH**  
Hollow bore output with dimensions that drop-in for many right angle and inline gear reducers

*Precision (8-15 arcmin) - Gear Reducers - Motion Control*

Inline ■ Right Angle ■

**EPL Series**

Performance inline planetary gearbox for general applications

- Lowest backlash <8 arcmin
- Torque capacity up to 340 Nm
- Torsional rigidity up to 33 Nm/arcmin
- Radial load capacity up to 8,500 N
- Frame sizes from 50-150 mm
- Stainless Steel SSP-W available in frame sizes 70-120 mm

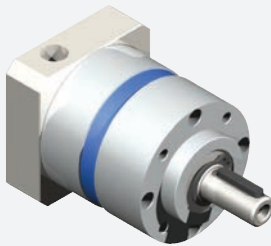

**EPL-W**  
Metric shaft output



**SSP-W**  
Stainless Steel



**EPL-H**  
Hollow output



**EPL-F**  
Flange output

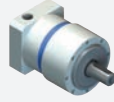

**EPL-A**  
Metric shaft output



**EPL-X**  
NEMA output

**EPR Series**

Performance right angle bevel planetary gearbox for general applications

- Lowest backlash <8 arcmin
- Torque capacity up to 340 Nm
- Torsional rigidity up to 33 Nm/arcmin
- Radial load capacity up to 8,500 N
- Frame sizes from 50-150 mm

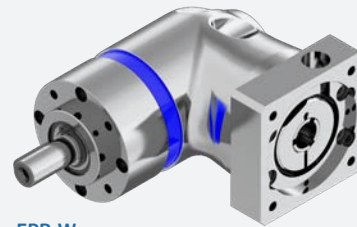

**EPR-W**  
Metric shaft output



**EPR-H**  
Hollow output

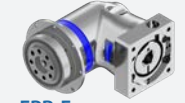

**EPR-F**  
Flange output

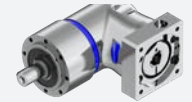

**EPR-A**  
Metric shaft output

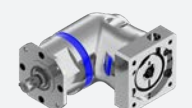

**EPR-X**  
NEMA output

**PE Series**

Basic performance inline planetary gearbox for general applications

- Lowest backlash <8 arcmin
- Torque capacity up to 210 Nm
- Torsional rigidity up to 17 Nm/arcmin
- Radial load capacity up to 2,500 N
- Frame sizes from 50-118 mm

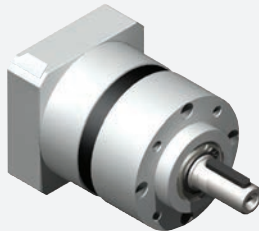

**PE-W**  
Metric shaft output



**PE-N**  
NEMA output

**PER Series**

Basic performance right angle bevel planetary gearbox for general applications

- Lowest backlash <8 arcmin
- Torque capacity up to 210 Nm
- Torsional rigidity up to 17 Nm/arcmin
- Radial load capacity up to 2,500 N
- Frame sizes from 50-118 mm

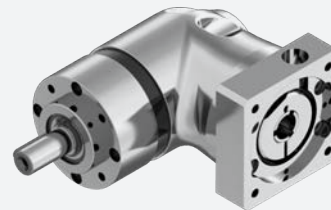

**PER-W**  
Metric shaft output



**PER-N**  
NEMA output

**Miniature VP Series**

High-performance spiral bevel gearboxes for miniature applications, such as medical and semiconductor, when high performance is required and space is at a premium

- Highest precision, smallest bevel gearbox on the market
- Highest torque density for the size with torque capacity of 1.3-16 Nm
- 90% Efficiency
- Ratios 1:1 to 4:1
- Frame sizes from 27-45 mm



**VP**  
Shaft or hollow output



**VPC**  
with integrated motor mount

**V-Series**

Performance spiral bevel gearbox for general applications

- Lowest backlash <15 arcmin
- Torque capacity up to 4,640 Nm
- Radial load capacity up to 34,200 N
- Frame sizes from 35-350 mm
- Ratios 1:1 to 6:1
- VC Series ratios up to 100:1 on select models



**V-CO**  
Shaft output / shaft input



**VC-W**  
Shaft output with motor mount



**V-DO**  
Dual shaft output / shaft input (more than 13 shaft configurations available)

## Mechanical Drive Solutions

### Bellows Couplings

- Zero backlash and high stiffness for all motion control applications
- Torque capacity up to 4,000 Nm



KM Series



KP Series



KLC Series



KG Series



KR Series



KSS Series



KG-VA Series



KGH Series



KSD Series



KHS Series



KPP Series



KPS Series

### Elastomer Couplings

- Lower cost alternatives for applications with less precision requirements
- Torque capacity up to 2,000 Nm



EKC Series



EKM Series



ESM-A Series

### Distance Couplings

- Drive shafts with customized lengths up to 20 ft
- Torque capacity up to 1,600 Nm



EDC Series



WDS Series

### Safety Couplings

- Disengage when a specified torque level is reached to protect machine components
- Torque capacity up to 9,000 Nm

#### Direct Drive



SKB-KP Series



SKY-KS Series



SKW-KP Series



SKB-EK Series



SKY-ES Series

#### Indirect Drive



SKB Series



SKY Series



SKW Series



SKX-L Series



SKG Series

### Mounting Kits

- Connect any motor or gearbox to any actuator
- Torque capacity up to 150 Nm

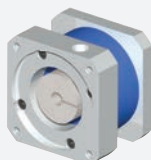

**LSK**  
Inline motor  
mounting kit



**PMK**  
Parallel  
mounting kit

## Broadest automation product range on the market

GAM is your complete source for innovative products used in automation technology.

### Robotic Gearboxes

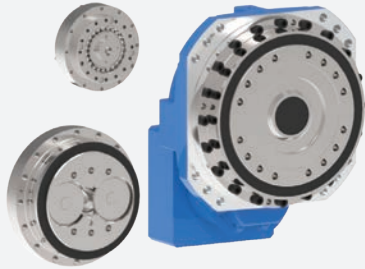

Zero-backlash gearboxes for robotics and high-precision applications with revolutionary zero-backlash planetary, cycloidal, or strain-wave (harmonic) gearing

### Servo Gearboxes

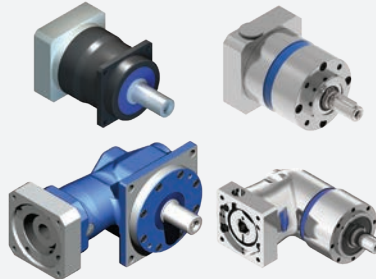

In-line and right angle gearboxes for precision servo applications in a wide variety of configurations and frame sizes. Off-the-shelf or custom, GAM has the gearbox for your application

### Bevel Gearboxes

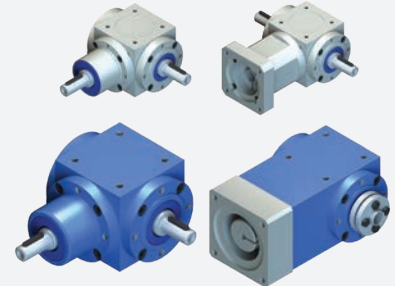

Precision spiral bevel gearboxes, from miniature to extremely large, with multiple shaft configuration options for servo or precision power transmission applications

### Servo Couplings



Bellows, elastomer, safety, or distance (line shaft) couplings are all zero-backlash and custom bored

### Rack & Pinion Systems

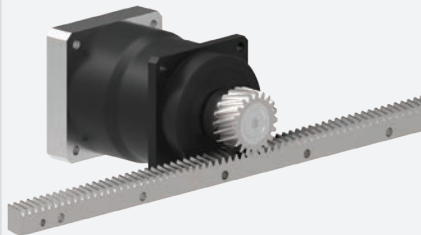

Helical rack and pinion pair with GAM gearboxes for optimal system performance in a complete linear system. GAM rack available separately

### Linear Mounts

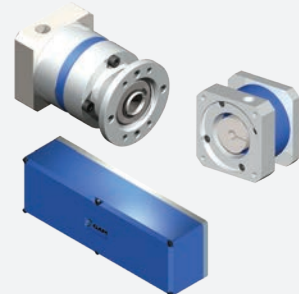

Everything Between the Motor and the Actuator: GAM linear mounts make it easy to connect any motor to any actuator.



GAM, a U.S. company, is your complete source for robotic and servo gear reducers, rack and pinion systems, servo couplings, linear mounting kits, and other precision mechanical drive solutions used in automation technology.

With one of the largest product offerings in the motion control industry as well as the engineering expertise and manufacturing capabilities to develop customized solutions, GAM can help with your application.

U.S. manufacturing, being flexible to meet the needs of customer requests, and great service are what set us apart from the rest.

GAM Can.

GAM Enterprises, Inc.  
801 E. Business Center Drive | Mt. Prospect, IL 60056  
Toll-Free: 888.GAM.7117 | Ph: 847.649.2500 | Fax: 847.649.2501  
www.gamweb.com | info@gamweb.com

